

Double Ridged Horn Antenna – Model DRH50

Electrical Specifications

Frequency Range	4.5 GHz – 50 GHz
VSWR (max.)	< 1.55:1
Impedance	50 Ω
Connector	2.40mm female
Power (CW / Pulse)	10 W / 20 W

Physical Specifications

Width	43.8 mm (1.724 in)
Depth	53.7 mm (2.114 in)
Height	38.0 mm (1.496 in)
Weight	70 g (0.16 lb)



Typical Parameters

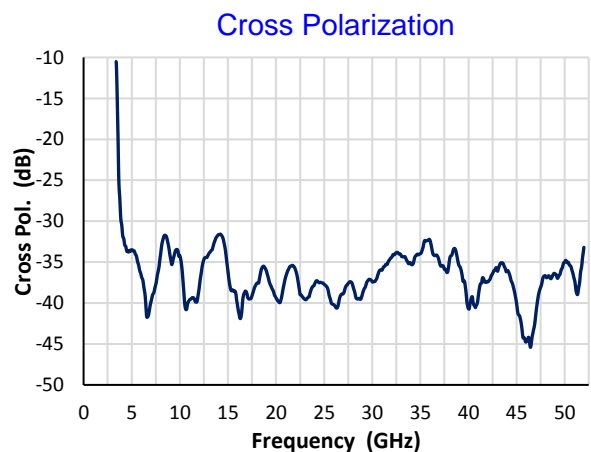
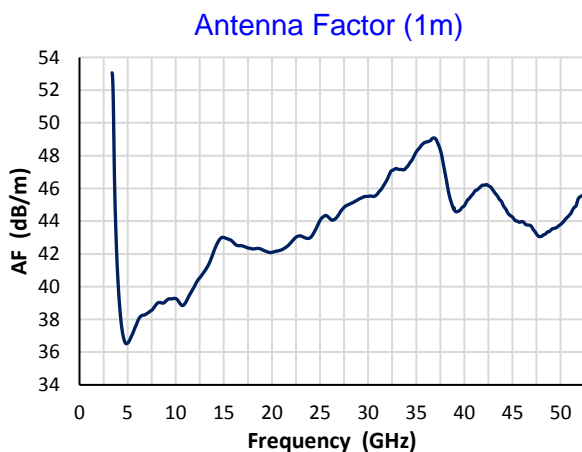
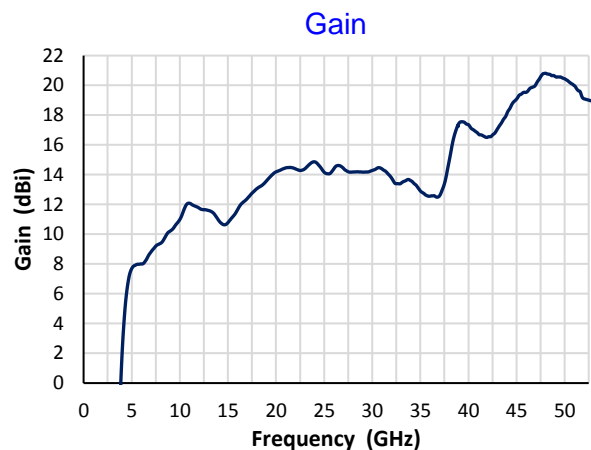
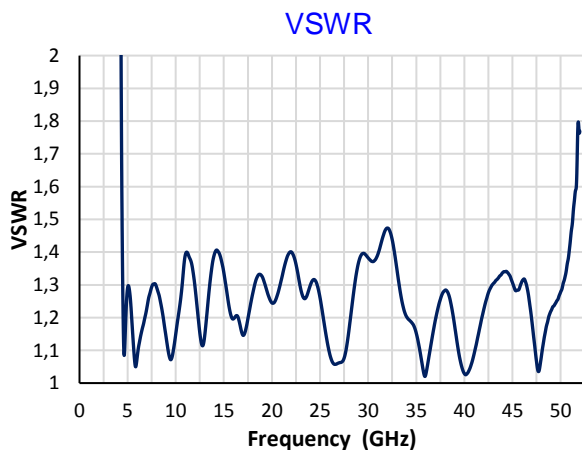

Radiation Patterns

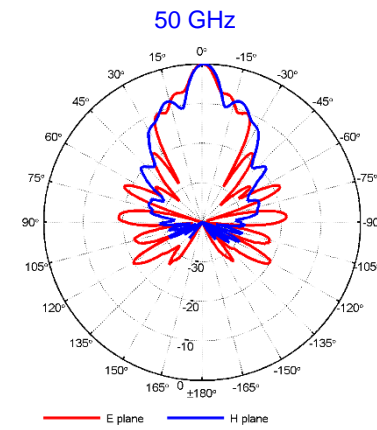
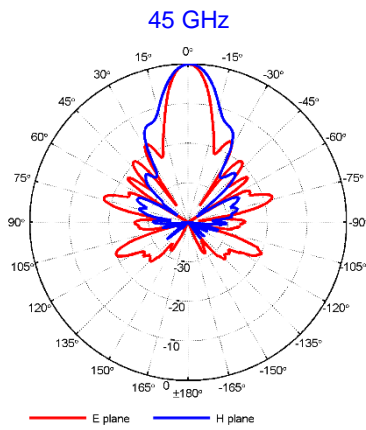
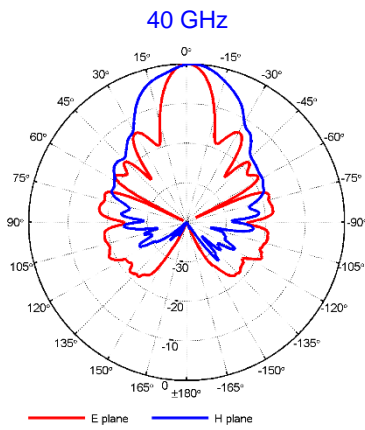
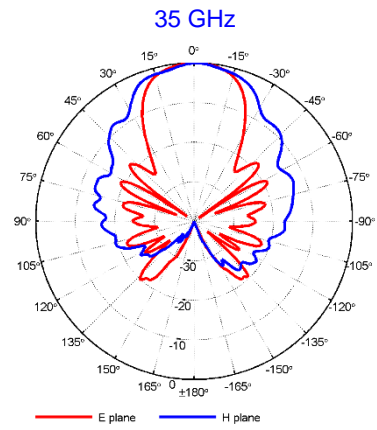
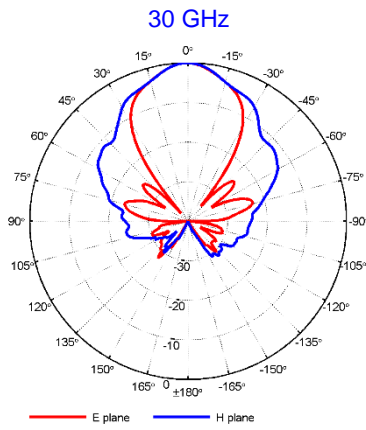
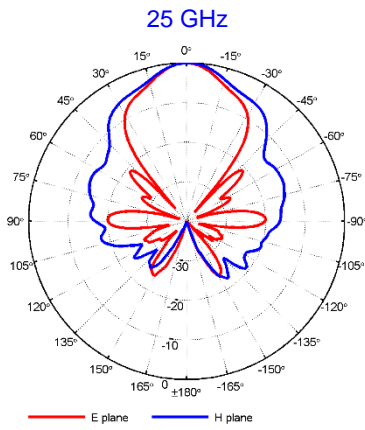
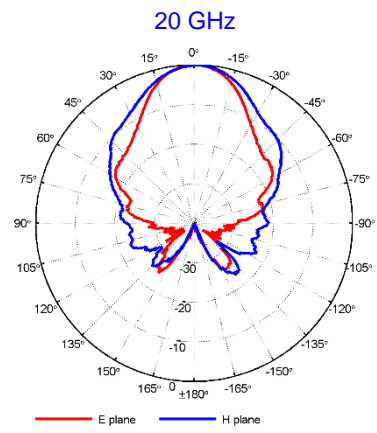
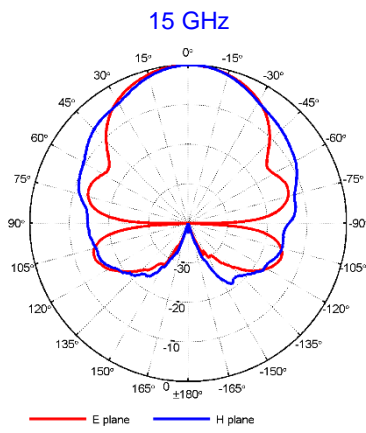
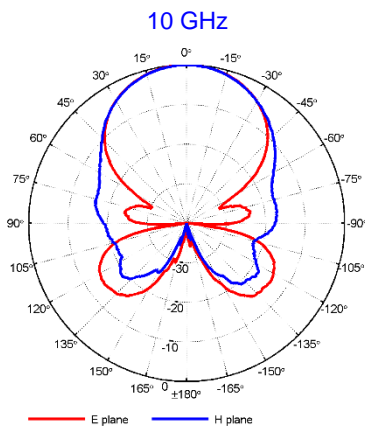
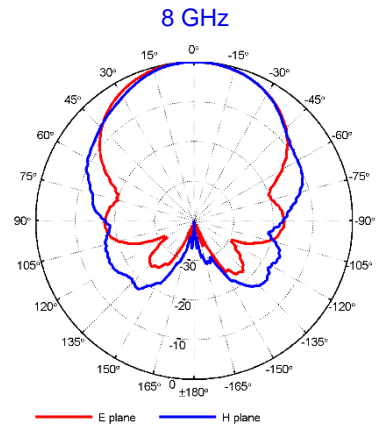
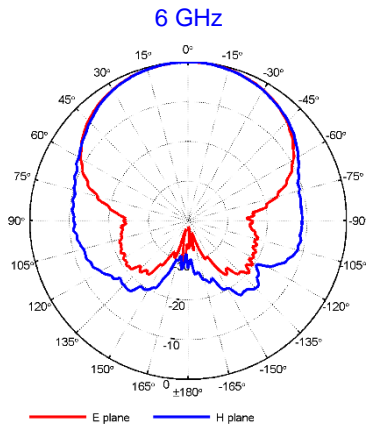
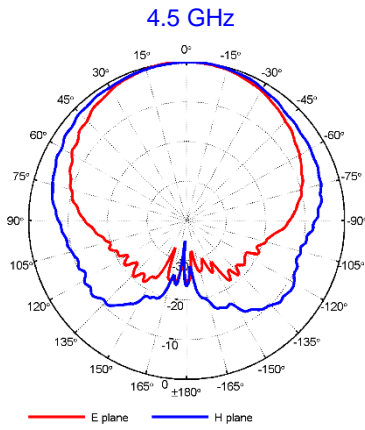

Beamwidth

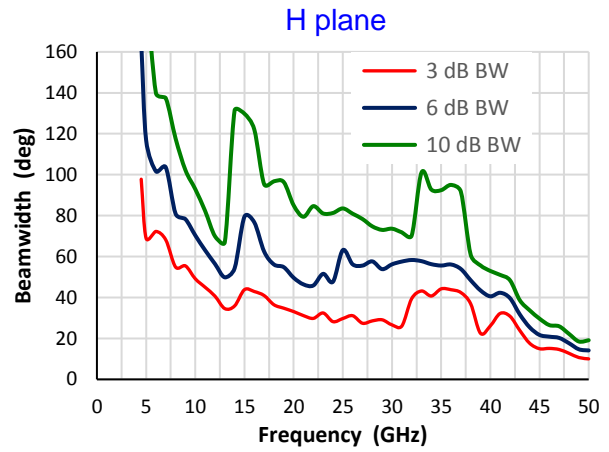
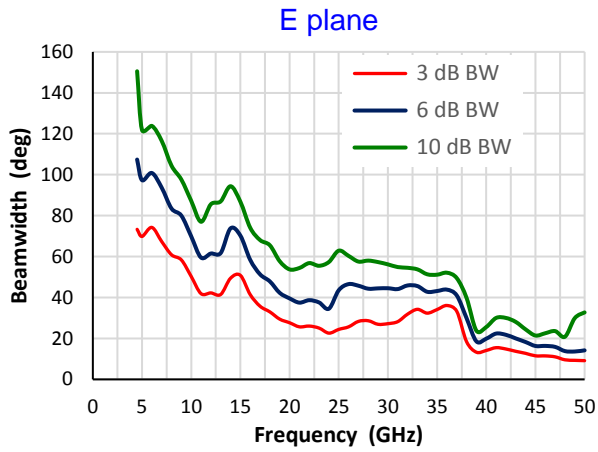

Schematic drawing

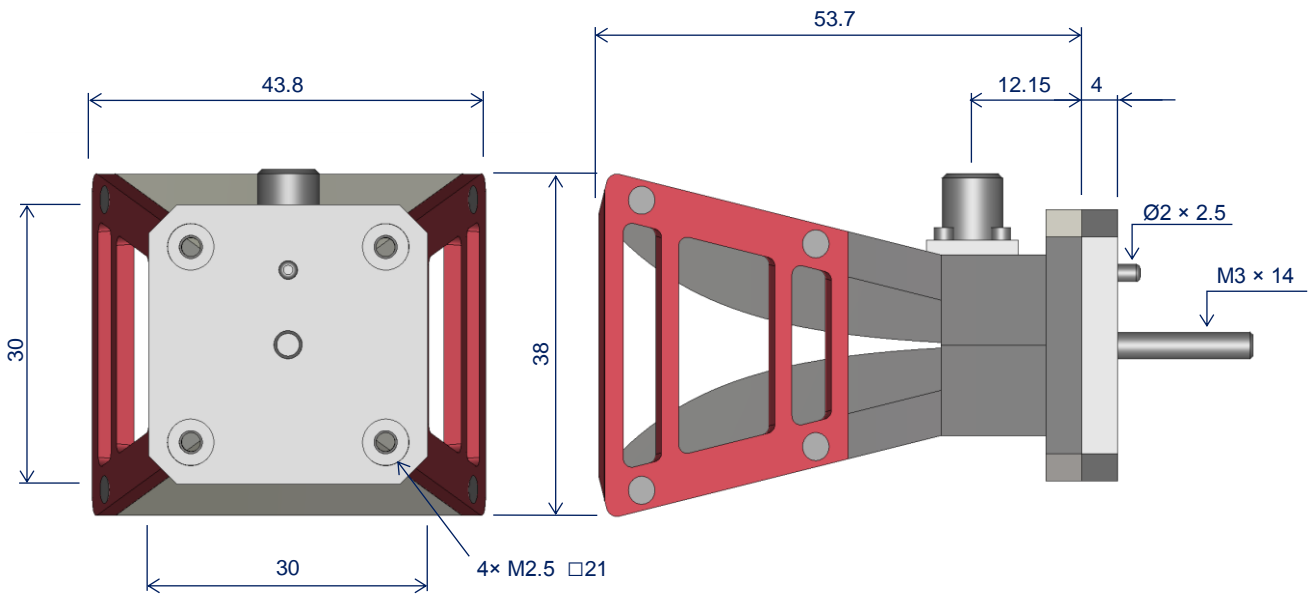

L bracket

